

Existing Front Elevation

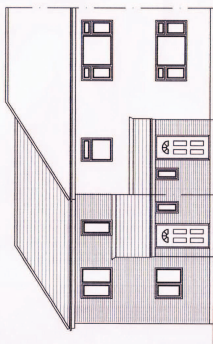

Proposed Front Elevation

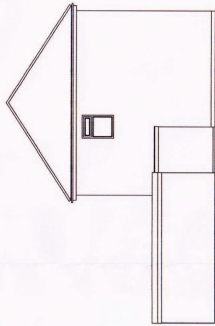

Existing Side Elevation

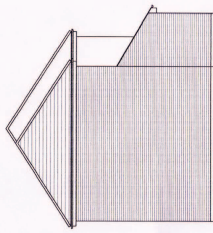

Proposed Side Elevation

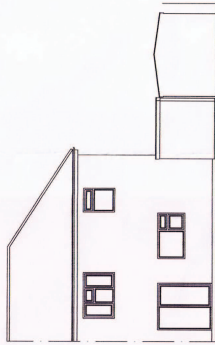

Existing Rear Elevation

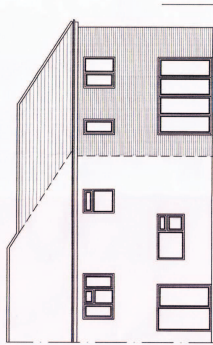

Proposed Rear Elevation

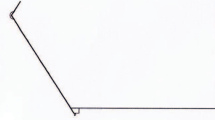

Existing Side Elevation



Proposed Side Elevation

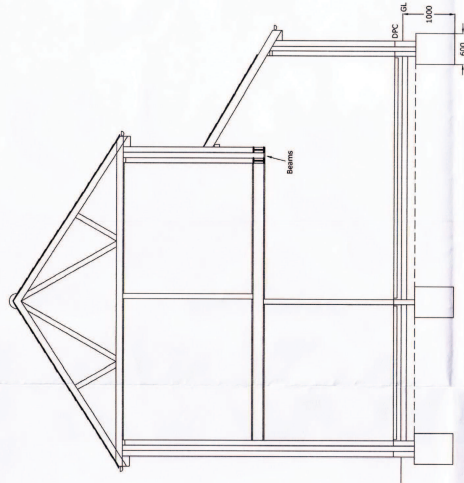

Section

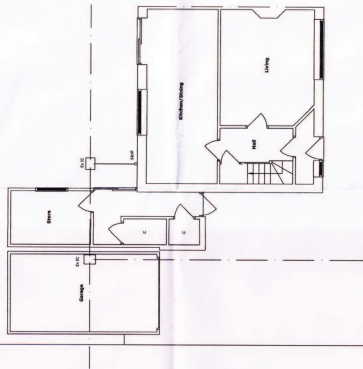

Existing Ground Floor

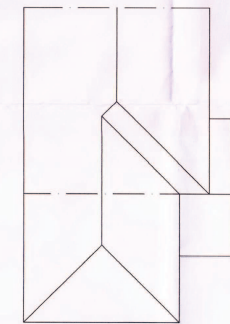

Roof Plan



Existing First Floor

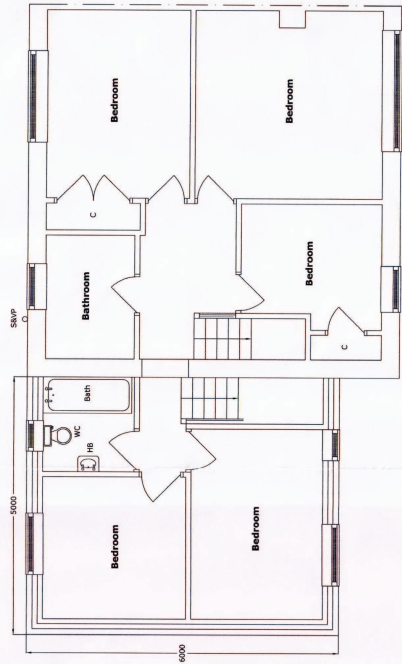

Proposed First Floor

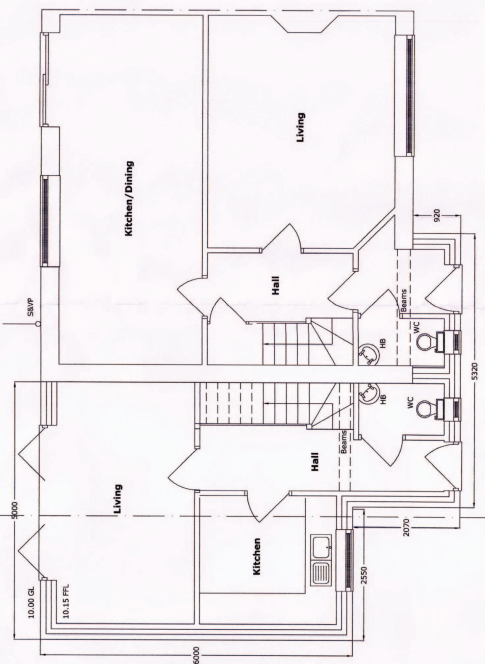

Proposed Ground Floor

This drawing and any design shown upon it is the copyright of Michael Bullivant Associates and may not be altered, photographed, copied or reproduced without their written consent.

Michael Bullivant Associates

2A Golding Road

Cambridge CB1 3RP

01223 242491

Proposed New Dwelling Adj. to

104 Wulfstan Way, Cambridge

For Mr Geoghan

Scale

1 : 50 & 100

Drwg. No.

6126

Date

June 2013

Revised